

# Contents

- Installation Requirements ..... 3
- Tool Requirements ..... 3
- Installation Instructions ..... 5
- Connector Information ..... 25

# Notes:

# Installation Requirements

- The IBM Personal Computer Data Acquisition and Control Adapter can be installed in the system unit or in the expansion unit.
- The IBM Personal Computer Data Acquisition and Control Adapter is designed to share its Interrupt-request (IRQ) level (determined by the position of switches). All adapters that share the same IRQ level must be installed in the same unit.
- Each IBM Personal Computer Data Acquisition and Control Adapter installed in a system must have a different adapter number.
- When installing your IBM Personal Computer Data Acquisition and Control Adapter, use the recommended switch settings if you are not familiar with the concept of IRQ levels. If you cannot use the recommended switch settings, refer to the *Technical Reference* manual to determine if conflicts will occur with any adapters installed in your system.
- Note the position of all option cables attached to your system for reference when cabling your system.

## Tool Requirements

- Medium-size, flat-blade screwdriver

Optional:

- Medium screwstarter
- 3/16-inch nutdriver
- 1/4-inch nutdriver.

# Notes:

# Installation Instructions

- 1** If you are installing this option in an IBM Portable Personal Computer system unit, go to Step 13.
- 2** Set the Power switch on the system unit (and expansion unit, if attached) to Off.
- 3** Set the Power switches on all attached devices, such as a printer or TV, to Off.
- 4** Unplug the system unit's (and expansion unit's) power cord from the wall outlet.
- 5** Note the locations of all cables at the back of your system, then disconnect them.

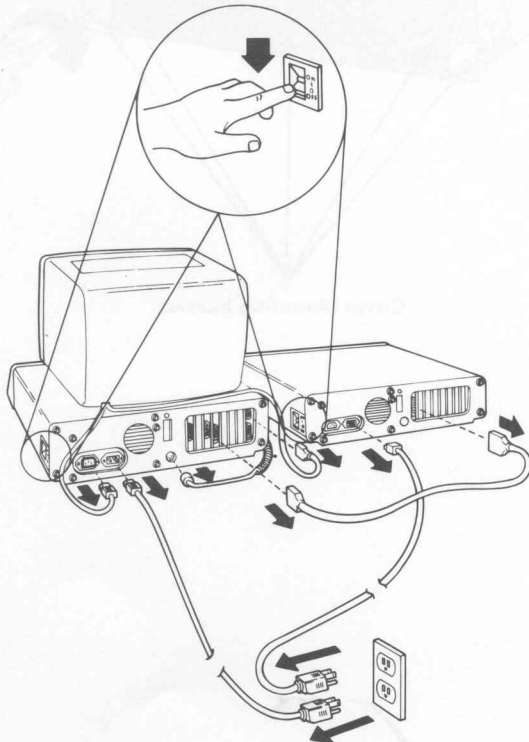

- 6 Move your keyboard and all disconnected devices away from the work area.
- 7 Move the unit in which you are installing the adapter (system unit or expansion unit) to allow access to the rear.
- 8 Use a flat-blade screwdriver or 1/4-inch nutdriver and remove the cover mounting screws by turning them counterclockwise as shown below. Save the screws for the installation of the cover.

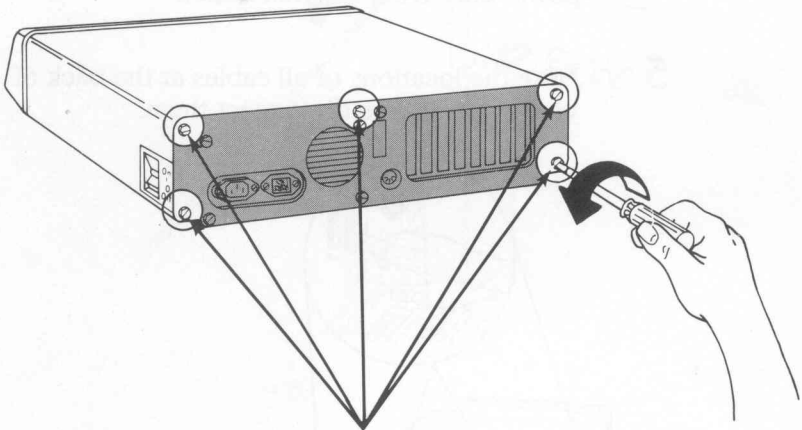

Cover Mounting Screws

9

Carefully slide the unit's cover away from the rear and to the front, as shown in the figure below. When the cover will go no farther, tilt it up, remove it from the base, and set it aside.

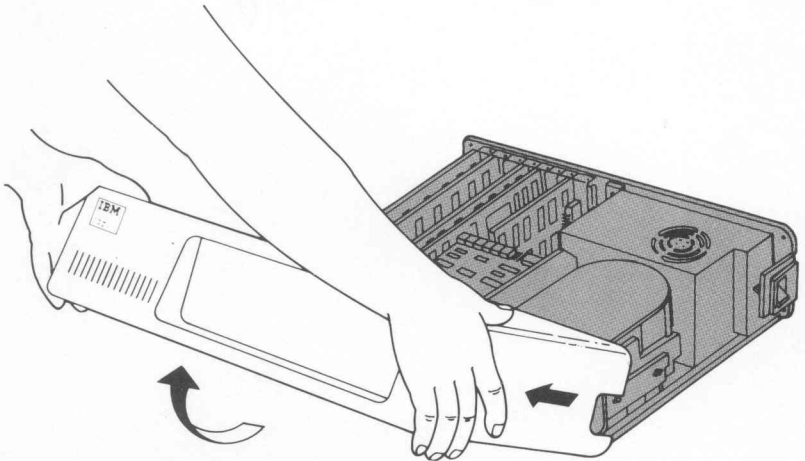
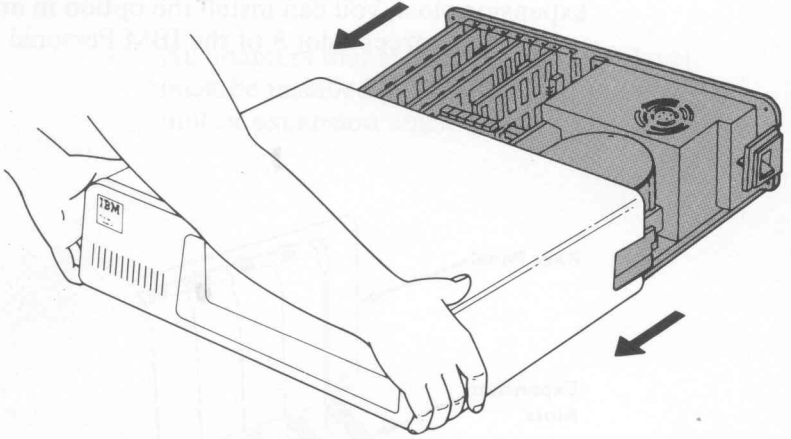

**10** With the front of the unit toward you, look at the expansion slots inside the unit. The expansion slots are numbered from the left, beginning with slot 1. Your unit may have either five or eight expansion slots. If your unit has only five expansion slots, you can install the option in any unused slot. If your unit has eight expansion slots, you can install the option in any unused slot, except slot 8 of the IBM Personal Computer XT.

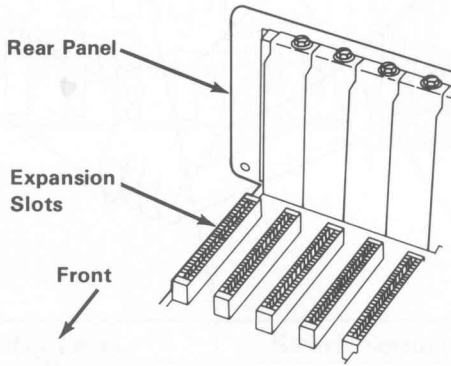



- 11** Use a flat-blade screwdriver or 3/16-inch nutdriver and remove the screw that holds the expansion slot's cover in place by turning the screw counterclockwise. Save the screw for the installation of the option. Remove the expansion slot's cover.

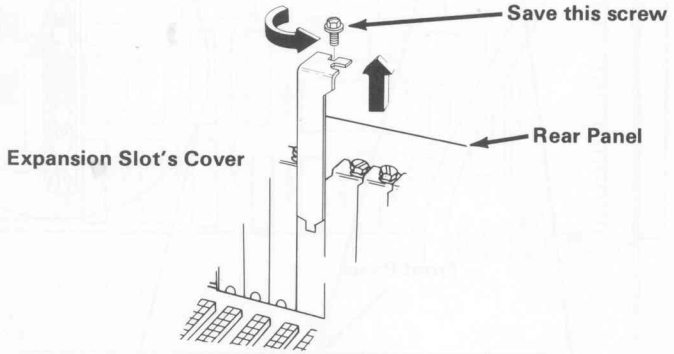

12

Press the card support bracket into the holes in the front panel of the unit. The holes used must correspond to the expansion slot selected for installation of the adapter. (The card support bracket is in your option package.)

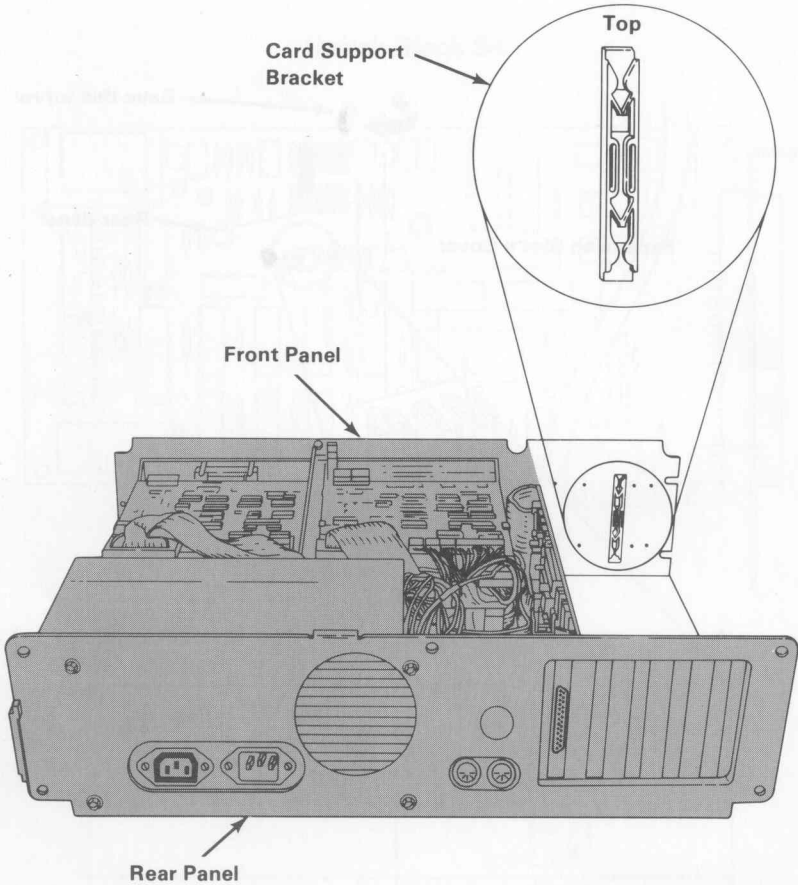

**13** Your IBM Personal Computer Data Acquisition and Control Adapter has switches that allow you to change its configuration.

The IBM Personal Computer Data Acquisition and Control Adapter is preset as follows:

- Adapter number 0
- D/A channel 0 = -10 to +10 Volts
- D/A channel 1 = -10 to +10 Volts
- A/D = -10 to +10 Volts
- IRQ level 7 (recommended)

If this is the first IBM Personal Computer Data Acquisition and Control Adapter in your system, and you intend to use the preset switch settings, go to Step 15.

**Note:** Each additional adapter must have a different adapter number.

If any switches must be changed, continue with the next step.

**14** Place the Data Acquisition and Control Adapter on a flat surface with the components facing up.

To change the position of a switch, use the tip of a ball point pen and set the switch to the desired position, as shown below.

Use the information on the following pages to determine the switch positions for your selections.

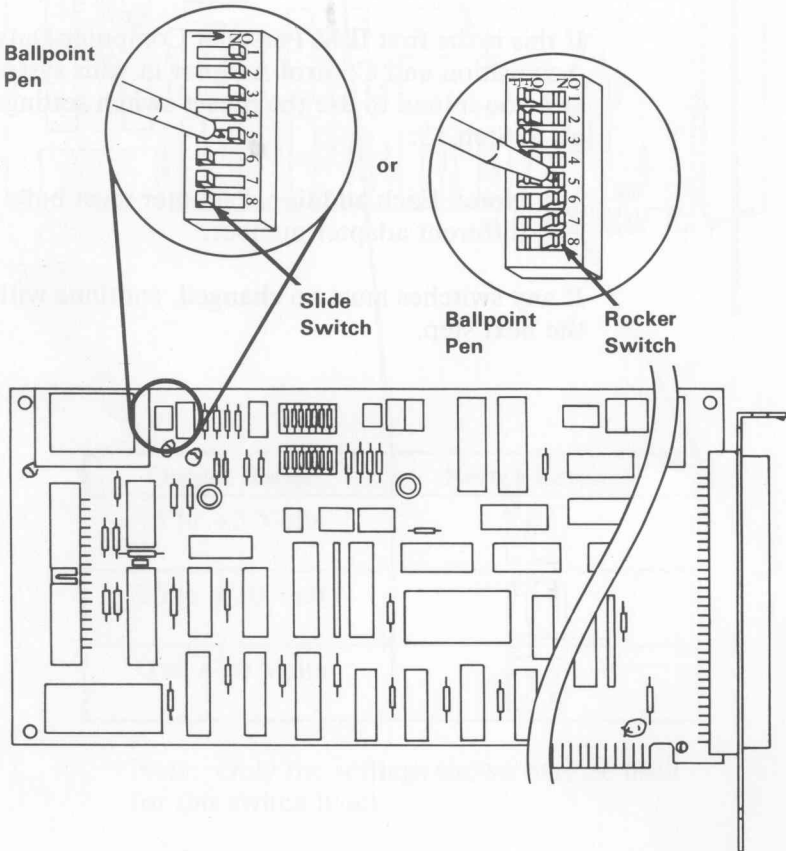



## Analog Output Range (D/A) Channel 0

The analog output range for channel 0 is selected with the switches shown below.

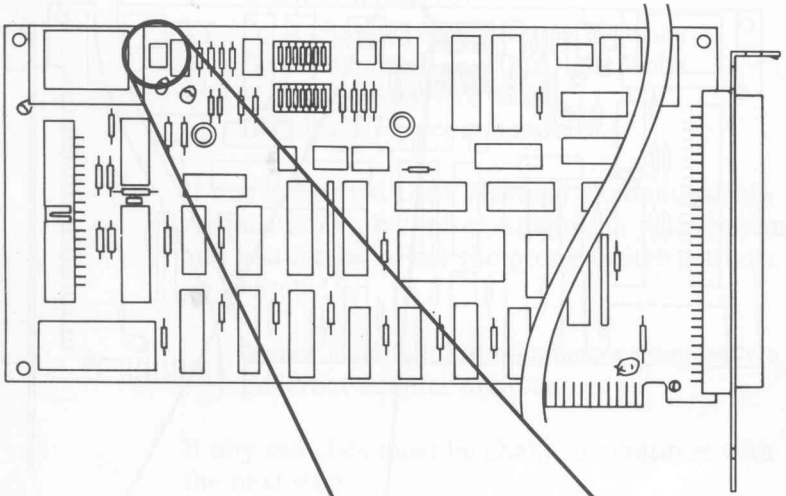
### Switch Block S1



Output Range	Switch Settings
-5 to +5 Volts	
-10 to +10 Volts	
0 to +10 Volts	

**Note:** Only the settings shown may be used for this switch block.

## Analog Output Range (D/A) Channel 1

The analog output range for channel 1 is selected with the switches shown below.

### Switch Block S2

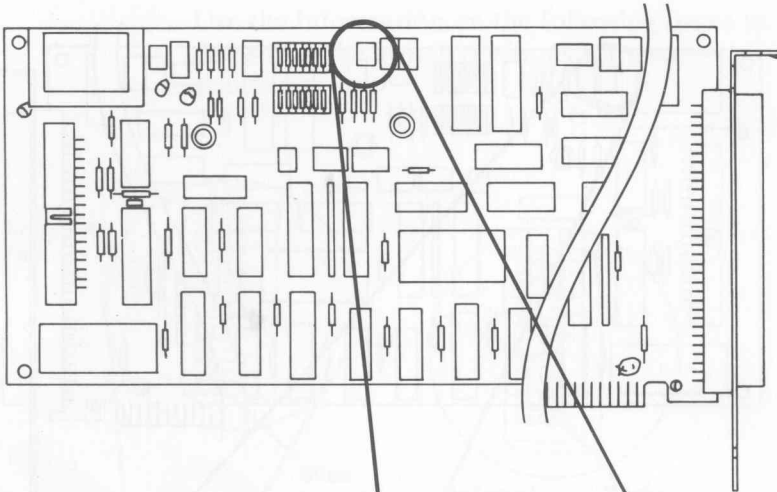

Output Range	Switch Settings
-5 to +5 Volts	
-10 to +10 Volts	
0 to +10 Volts	

**Note:** Only the settings shown may be used for this switch block.

## Analog Input Range (A/D)

The analog input range is selected with the switches shown below.

### Switch Block S3

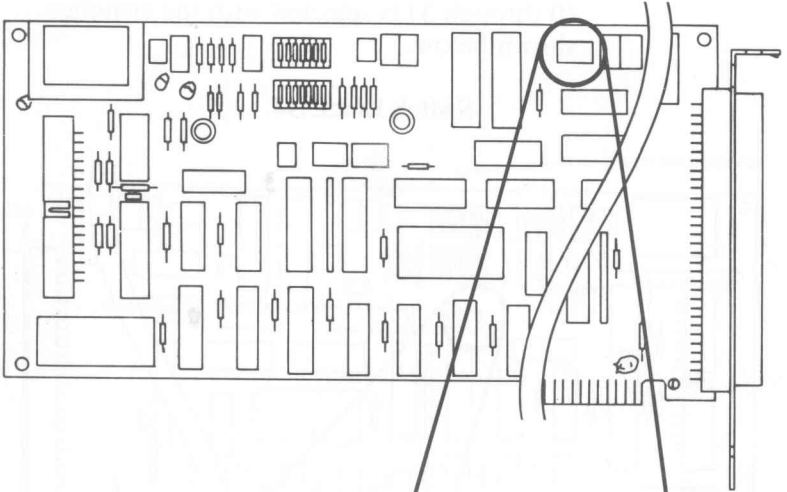

Input Range	Switch Settings
-5 to +5 Volts	
-10 to +10 Volts	
0 to +10 Volts	





**Note:** Only the settings shown may be used for this switch block.

## Adapter Number

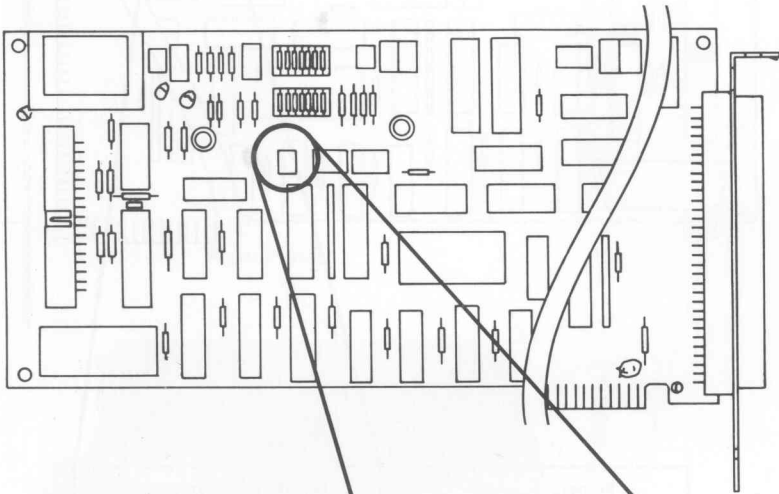
A maximum of four IBM Data Acquisition and Control Adapters can be installed in a system (system unit with expansion unit), if expansion slots are available. Each adapter must have a different adapter number. The adapter number (0 through 3) is selected with the switches shown below.

### Switch Block S4



Adapter Number	Switch Positions
0	
1	
2	
3	



## **Interrupt-Request (IRQ) Level**

The Data Acquisition and Control Adapter is designed to share its IRQ level with other adapters, however:

- The other adapters must be designed to share an IRQ level.
- All adapters that share the same IRQ level must be installed in the same unit (system unit or expansion unit).

The IRQ level used by the Data Acquisition and Control Adapter is selected with the switches shown below.

### Switch Block S5

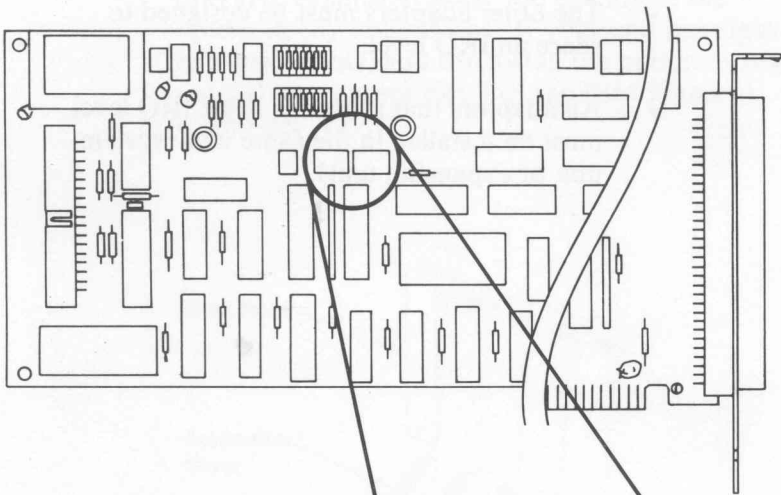

IRQ Level	Switch Settings
7 (Recommended)	
6	
5	
4	
3	

**Note:** Only the settings shown may be used for this switch block.

**15** Go to page Test 3800-3 in the "Problem Determination Procedures" of your *Guide to Operations* manual. Record the adapter IRQ level and the unit in which it is to be installed, in the space provided. Then, return here and continue.

**Note:** Remember to update the information if you make changes to your installed IBM Data Acquisition and Control Adapters.

**16** If you are installing your Data Acquisition and Control Adapter in an IBM Portable Personal Computer system unit continue at the beginning of "Option Installation" in your *Guide to Operations* manual.

**17** Hold the adapter by the top and press it firmly into the expansion slot, as shown below.

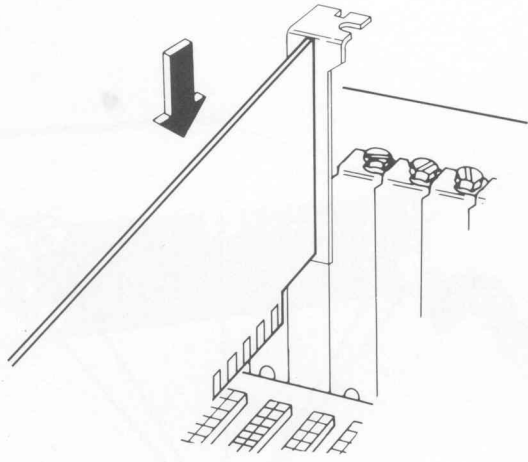

**18**

Align the slot in the adapter retaining bracket with the hole in the rear panel of the unit. Start the screw clockwise, then tighten with a flat-blade screwdriver or 3/16-inch nutdriver.

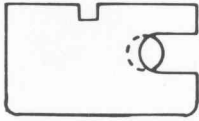

**Not  
Aligned**

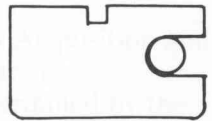
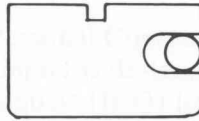

**Properly  
Aligned**

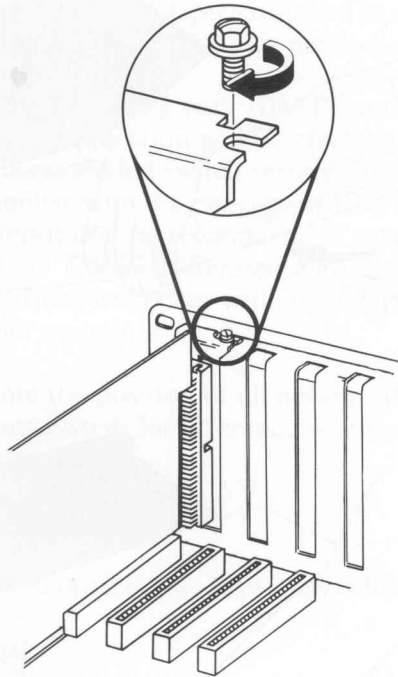

**19** If you have any other options to install, do so now before putting the unit's cover back on.

**20** Put the unit's cover on by placing it as shown and carefully sliding it toward the rear of the unit.

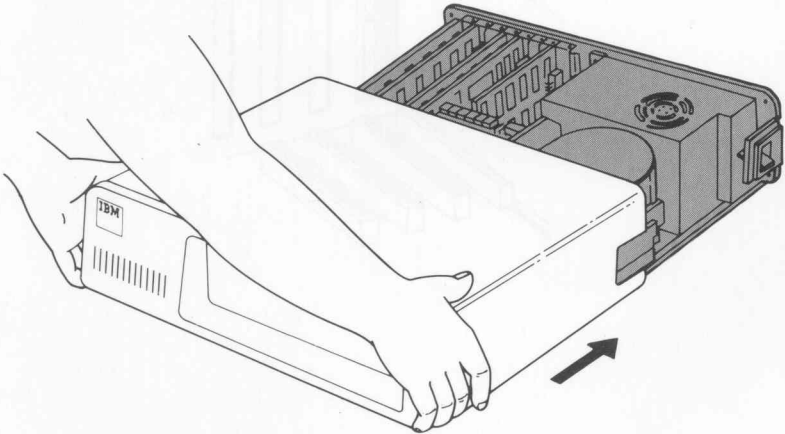
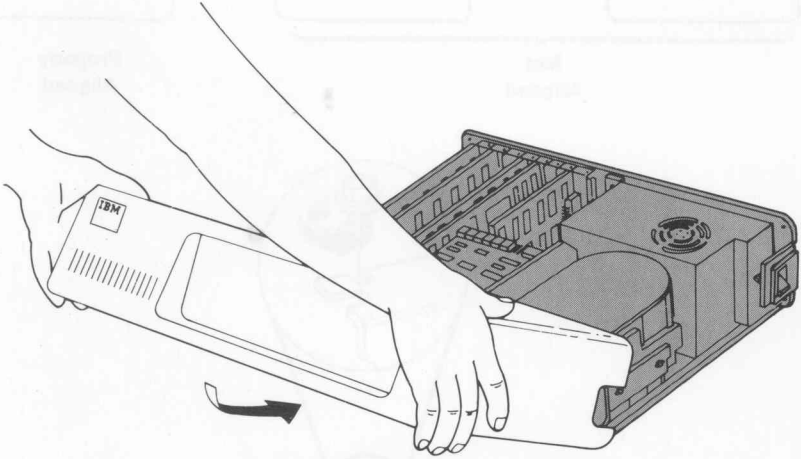

- 21** When the cover is all the way to the rear, align the screws with the threaded tabs and tighten. Use a flat-blade screwdriver or 1/4-inch nutdriver and turn clockwise.

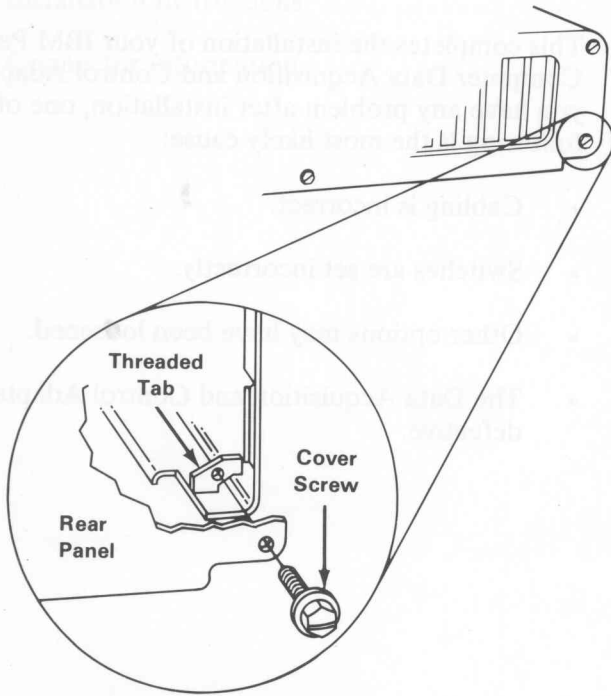

**22** Your system unit (and expansion unit, if attached) is now ready to be cabled. Refer to the cable positions that you noted and the section titled "Setup" or "Introduction/Installation" in your *Guide to Operations* manual.

This completes the installation of your IBM Personal Computer Data Acquisition and Control Adapter. If you have any problem after installation, one of the following is the most likely cause:

- Cabling is incorrect.
- Switches are set incorrectly.
- Other options may have been loosened.
- The Data Acquisition and Control Adapter is defective.



# Connector Information

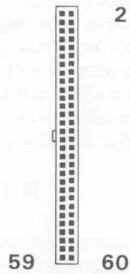

	Signal Name	Pin	
	D/A 1	1	
	D/A 0	2	
	+10V REF	3	
	A GND	4	
	A/D 0-	5	
	A/D 0	6	
	A/D 1-	7	
	A/D 1	8	
	A/D 2-	9	
	A/D 2	10	
	A/D 3-	11	
IBM Distribution Panel Connector	A/D 3	12	IBM Data Acquisition Adapter
	A GND	13	
	A/D CE	14	
	D GND	15	
	A/D CO	16	
	BI 8	17	
	BO 8	18	
	BI 9	19	
	BO 9	20	
	BI 10	21	
	BO 10	22	
	BI 11	23	
	BO 11	24	
	BI 12	25	
	BO 12	26	
	BI 13	27	
BO 13	28		
BI 14	29		
	BO 14	30	

# Connector Information

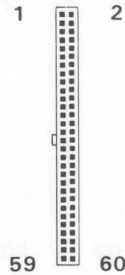

	Signal Name	Pin	
	BI 15	31	
	BO 15	32	
	BI HOLD	33	
	BO GATE	34	
	BI 0	35	
	BO 0	36	
	BI 1	37	
	BO 1	38	
	BI 2	39	
	BO 2	40	
	BI 3	41	
IBM Distribution Panel Connector	BO 3	42	IBM Data Acquisition Adapter
	BI 4	43	
	BO 4	44	
	BI 5	45	
	BO 5	46	
	BI 6	47	
	BO 6	48	
	BI 7	49	
	BO 7	50	
	RATE OUT	51	
	DELAY OUT	52	
	BI STROBE	53	
	BO STROBE	54	
	BO CTS	55	
	BI CTS	56	
	IRQ	57	
COUNT OUT	58		
COUNT IN	59		
	D GND	60	

# Notes:

# Notes:

# IBM Personal Computer Data Acquisition and Control Adapter Installation Instructions for the:

- IBM Personal Computer
- IBM Personal Computer XT
- IBM Portable Personal Computer
- IBM Personal Computer Expansion Unit

This option consists of:

- IBM Personal Computer Data Acquisition and Control Adapter
- Card Support Bracket
- *Guide to Operations* Update
- Wrap Plug
- Diagnostics Diskette

If any items are missing or damaged, notify your place of purchase.

**6138199**

August 15, 1984

© Copyright IBM Corporation 1984

The warranty terms and conditions applicable in the country of purchase (except for the U.S. and Puerto Rico) in respect of an IBM Personal Computer product are available from the supplier. Please retain them with your proof of purchase.

## **LIMITED WARRANTY (APPLIES TO U.S. AND PUERTO RICO ONLY)**

The International Business Machines Corporation warrants this IBM Personal Computer Product to be in good working order for a period of one year from the date of purchase from IBM or an Authorized IBM Personal Computer Dealer. Should this Product fail to be in good working order at any time during this one year warranty period, IBM will, at its option, repair or replace this Product at no additional charge except as set forth below. Repair parts and replacement Products will be furnished on an exchange basis and will be either reconditioned or new. All replaced parts and Products become the property of IBM. This limited warranty does not include service to repair damage to the Product resulting from accident, disaster, misuse, abuse, or non-IBM modification of the Product.

Limited Warranty service may be obtained by delivering the Product during the one year warranty period to an Authorized IBM Personal Computer Dealer, or any IBM Service/Exchange Center and providing proof of purchase date. If this Product is delivered by mail, you agree to insure the Product or assume the risk of loss or damage in transit, to prepay shipping charges to the warranty service location and to use the original shipping container or equivalent. Contact an Authorized IBM Personal Computer Dealer or write to IBM Personal Computer, Sales and Service, P.O. Box 1328-W, Boca Raton, Florida 33432, for further information.

IBM HEREBY DISCLAIMS ALL OTHER EXPRESS AND IMPLIED WARRANTIES FOR THIS PRODUCT, INCLUDING THE WARRANTIES OF MERCHANTABILITY AND FITNESS FOR A PARTICULAR PURPOSE. SOME STATES DO NOT ALLOW THE EXCLUSION OF IMPLIED WARRANTIES, SO THE ABOVE LIMITATIONS MAY NOT APPLY TO YOU.

IF THIS PRODUCT IS NOT IN GOOD WORKING ORDER AS WARRANTED ABOVE, YOUR SOLE REMEDY SHALL BE REPAIR OR REPLACEMENT AS PROVIDED ABOVE. IN NO EVENT WILL IBM BE LIABLE TO YOU FOR ANY DAMAGES, INCLUDING ANY LOST PROFITS, LOST SAVINGS OR OTHER INCIDENTAL OR CONSEQUENTIAL DAMAGES ARISING OUT OF THE USE OF OR INABILITY TO USE SUCH PRODUCT, EVEN IF IBM OR AN AUTHORIZED IBM PERSONAL COMPUTER DEALER HAS BEEN ADVISED OF THE POSSIBILITY OF SUCH DAMAGES, OR FOR ANY CLAIM BY ANY OTHER PARTY.

SOME STATES DO NOT ALLOW THE EXCLUSION OR LIMITATION OF INCIDENTAL OR CONSEQUENTIAL DAMAGES FOR CONSUMER PRODUCTS, SO THE ABOVE LIMITATIONS OR EXCLUSIONS MAY NOT APPLY TO YOU.

THIS WARRANTY GIVES YOU SPECIFIC LEGAL RIGHTS, AND YOU MAY ALSO HAVE OTHER RIGHTS WHICH MAY VARY FROM STATE TO STATE.

FOR WARRANTY SERVICE OR ASSISTANCE IT IS RECOMMENDED THAT THIS PRODUCT BE RETURNED TO THE AUTHORIZED IBM PERSONAL COMPUTER DEALER FROM WHOM IT WAS PURCHASED OR TO ANY IBM SERVICE/EXCHANGE CENTER.

# FEDERAL COMMUNICATIONS COMMISSION RADIO FREQUENCY INTERFERENCE STATEMENT

**Warning:** The equipment described herein has been certified to comply with the limits for a Class B computing device, pursuant to Subpart J of Part 15 of FCC rules. Only peripherals (computer input/output devices, terminals, printers, etc.) certified to comply with the Class B limits may be attached to the computer. Operation with non-certified peripherals is likely to result in interference to radio and TV reception. If peripherals not offered by IBM are used with the equipment, it is suggested to use shielded grounded cables with in-line filters if necessary.

## INSTRUCTIONS TO USER

This equipment generates and uses radio frequency energy and if not installed and used properly, i.e., in strict accordance with the operating instructions, reference manuals, and the service manual, may cause interference to radio or television reception. It has been tested and found to comply with the limits for a Class B computing device pursuant to Subpart J of Part 15 of FCC Rules, which are designed to provide reasonable protection against such interference when operated in a residential installation.

If this equipment does cause interference to radio or television reception, which can be determined by turning the equipment off and on, the user is encouraged to try to correct the interference by one or more of the following measures:

- Reorient the receiving antenna.
- Relocate the equipment with respect to the receiver.
- Move the equipment away from the receiver.
- Plug the equipment into a different outlet so that equipment and receiver are on different branch circuits.
- Ensure that card mounting screws, attachment connector screws, and ground wires are tightly secured.
- Ensure that card slot covers are in place when no card is installed.
- If peripherals not offered by IBM are used with this equipment, it is suggested that you use shielded, grounded cables with in-line filters, if necessary.

If necessary consult your dealer service representative for additional suggestions.

The manufacturer is not responsible for any radio or TV interference caused by unauthorized modifications to this equipment. It is the responsibility of the user to correct such interference.

**CAUTION:** The product described herein is equipped with a grounded plug for the user's safety. It is to be used in conjunction with a properly grounded receptacle to avoid electrical shock.

# Notes:

FEDERAL COMMUNICATIONS COMMISSION  
FREQUENTLY INTERFERED STATEMENT

1. The applicant's complaint is based on the fact that the station, WJLA-TV, Channel 11, has been found to be in violation of the Commission's rules regarding the use of the word "frequent" in its advertising copy. The Commission has previously ruled that the word "frequent" is a relative term and its meaning is determined by the facts and circumstances of each case. In this case, the Commission has found that the station's use of the word "frequent" in its advertising copy is not in violation of the Commission's rules.

## INSTRUCTIONS TO APPLICANT

2. The applicant is advised that the Commission's decision in this matter is final and not subject to reconsideration. The applicant is also advised that the Commission's decision is based on the facts and circumstances of this case and does not constitute a finding of fault or a determination of liability. The applicant is further advised that the Commission's decision is based on the Commission's interpretation of the Commission's rules and is not binding on any other party.

3. The applicant is advised that the Commission's decision is based on the Commission's interpretation of the Commission's rules and is not binding on any other party. The applicant is further advised that the Commission's decision is based on the Commission's interpretation of the Commission's rules and is not binding on any other party.

4. The applicant is advised that the Commission's decision is based on the Commission's interpretation of the Commission's rules and is not binding on any other party. The applicant is further advised that the Commission's decision is based on the Commission's interpretation of the Commission's rules and is not binding on any other party.

5. The applicant is advised that the Commission's decision is based on the Commission's interpretation of the Commission's rules and is not binding on any other party. The applicant is further advised that the Commission's decision is based on the Commission's interpretation of the Commission's rules and is not binding on any other party.

6. The applicant is advised that the Commission's decision is based on the Commission's interpretation of the Commission's rules and is not binding on any other party. The applicant is further advised that the Commission's decision is based on the Commission's interpretation of the Commission's rules and is not binding on any other party.

7. The applicant is advised that the Commission's decision is based on the Commission's interpretation of the Commission's rules and is not binding on any other party. The applicant is further advised that the Commission's decision is based on the Commission's interpretation of the Commission's rules and is not binding on any other party.

8. The applicant is advised that the Commission's decision is based on the Commission's interpretation of the Commission's rules and is not binding on any other party. The applicant is further advised that the Commission's decision is based on the Commission's interpretation of the Commission's rules and is not binding on any other party.

9. The applicant is advised that the Commission's decision is based on the Commission's interpretation of the Commission's rules and is not binding on any other party. The applicant is further advised that the Commission's decision is based on the Commission's interpretation of the Commission's rules and is not binding on any other party.

10. The applicant is advised that the Commission's decision is based on the Commission's interpretation of the Commission's rules and is not binding on any other party. The applicant is further advised that the Commission's decision is based on the Commission's interpretation of the Commission's rules and is not binding on any other party.

**CAUTION:** The product shown herein is not to be used in the absence of the Commission's approval.

11	11.1
12	12.1
13	13.1
14	14.1
15	15.1
16	16.1
17	17.1
18	18.1
19	19.1
20	20.1
21	21.1
22	22.1
23	23.1
24	24.1
25	25.1
26	26.1
27	27.1
28	28.1
29	29.1
30	30.1
31	31.1
32	32.1
33	33.1
34	34.1
35	35.1
36	36.1
37	37.1
38	38.1
39	39.1
40	40.1
41	41.1
42	42.1
43	43.1
44	44.1
45	45.1
46	46.1
47	47.1
48	48.1
49	49.1
50	50.1